

Caos

ref. CA04A-6

6xCA04A

Pendant lamp
Lámpara colgante

86cm | 33,9in

Ø100cm | 39,4in

250cm | 98,4in



115x115cm | 45,3x45,3in

Caos Collection



MATERIAL FINISHES MATERIALES Y ACABADOS

LAMPSHADE TULIPA

Cord
Cordón

Color combination: 42-46-52
Combinación de colores: 42-46-52



or other combination with
u otra combinación con

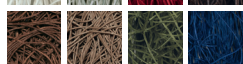

Stainless steel
Acero inoxidable

CANOPY AND CABLE
FLORÓN Y CABLE

DIBOND®

Transparent cable
Cable transparente

RECOMMENDED BULBS BOMBILLAS RECOMENDADAS

230V - 50Hz

 E27 LED Standard- Max. 6x12 W

 E27 LED Vintage- Max. 6x12 W

120V - 60Hz

E26 Med. - Max. 6x100 W

ENERGY EFFICIENCY EFICIENCIA ENERGÉTICA

from A+ to E
desde A+ a E

OTHER TECHNICAL DATA OTROS DATOS TÉCNICOS

NET WEIGHT | PESO NETO

14kg | 30,9lb

PACKAGING EMBALAJE

80x120x115cm | 31,5x47,2x45,3in
20kg | 44lb

ELECTRICAL FEATURES CARACTERÍSTICAS ELÉCTRICAS



CERTIFICATIONS CERTIFICACIONES



arturo alvarez

emotional light

Box contains | Contenido de la caja:

A - Lampshade | Tulipas [6]

B - Canopy | Florón [1]

C - Frame | Soporte [1]

D - Cap | Tapón [3]

E - Screws | Tornillos [4]

F - Wall plug | Tacos [4]

G - Electrical disposal | Ficha de conexión [1]

ref. **CA04A - 6**

Suitable for indoor use, at 25°C

Apta para uso interior a temperatura ambiente de 25°C

ASSEMBLY INSTRUCTIONS | INSTRUCCIONES DE MONTAJE

FRONTAL VIEW | VISTA FRONTAL

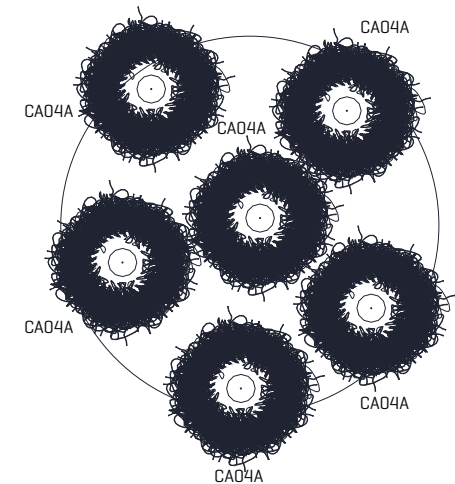
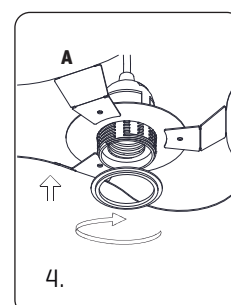
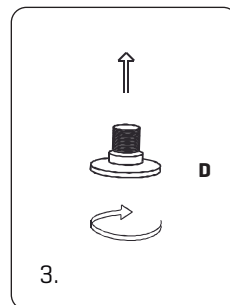
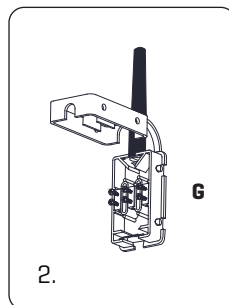
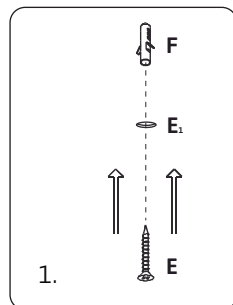
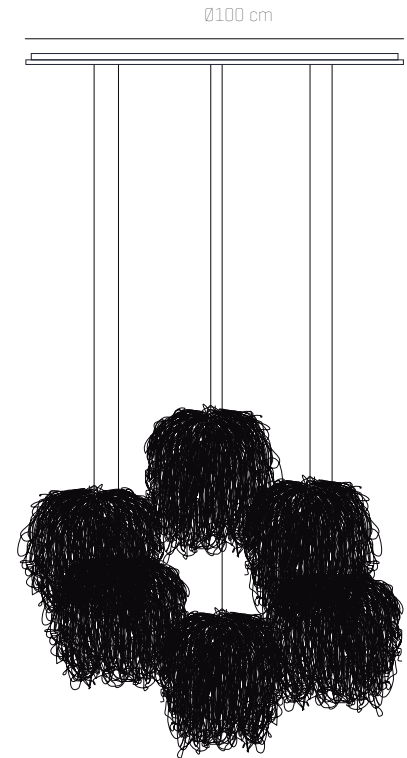
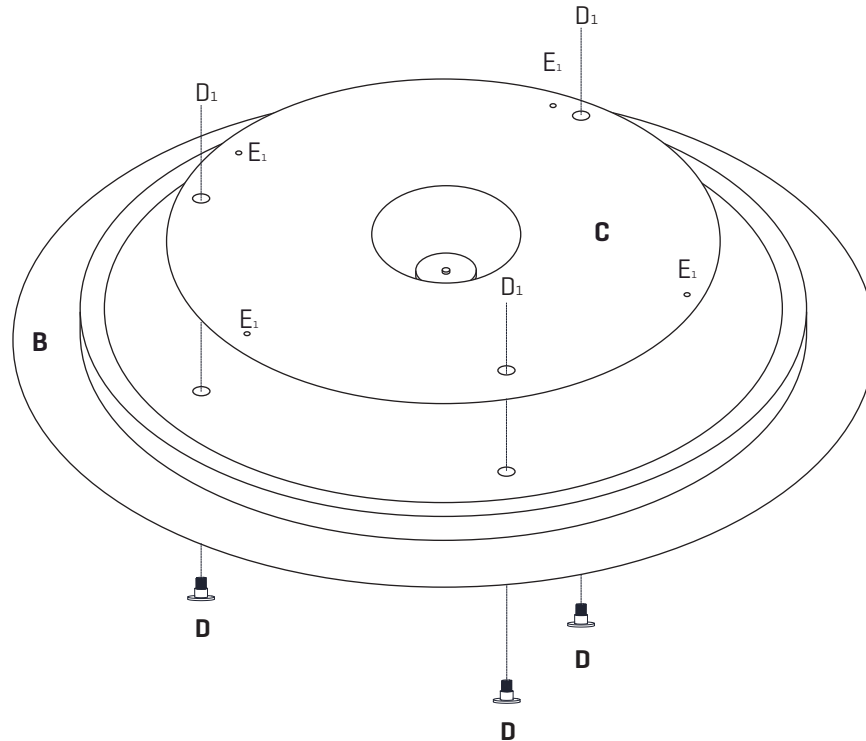

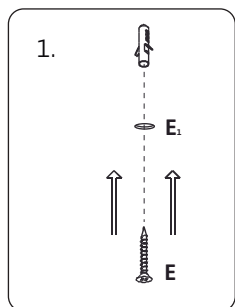

1. Make holes in the ceiling as marked in the frame with the letter E., insert the wall plugs and fix the frame.

* Our plugs are appropriate for concrete ceilings only

1. Hacer los taladros en su techo según los marcados en el soporte con la letra E., colocar los tacos y fijar el soporte.

* Nuestros tacos son sólo aptos para superficies de hormigón

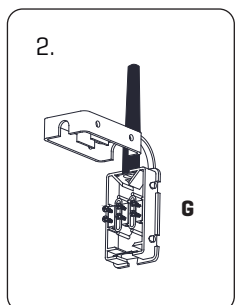

2. Pass the electrical wires inside the electrical disposal G.

The power cables from the wall shouldn't exceed the dimension of the black hose connection box provided, as shown in Fig. 2.1

Make the electrical connections taking care to respect the correct polarity as the color code.

2. Pasar los cables eléctricos al interior de la caja de conexiones G.

Los cables de alimentación procedentes de la pared no deben exceder la dimensión del manguito negro de la caja de conexiones suministrada, tal y como se indica en la figura 2.1

Realizar la conexión eléctrica teniendo cuidado de respetar la polaridad correcta según el código de colores.



COLOR CODE: PHASE [L] - BLACK OR BROWN / NEUTRAL [N] - BLUE / EARTHING [⊕] - GREEN&YELLOW

CÓDIGO DE COLORES: FASE [L] - NEGRO O MARRÓN / NEUTRO [N] - AZUL / TOMA TIERRA [⊕] - VERDE&AMARILLO

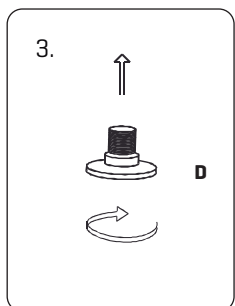

3. Once the frame is fixed, screw the caps in the holes marked with D.

3. Colocado el soporte, enroscar los tapones en los taladros marcados con la letra D.

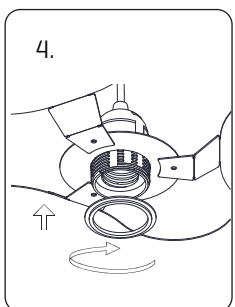

4. Insert the lampshade into the lampholder and tighten the nut.

4. Encajar la tulipa en el portalámparas y apretar la tuerca.